

LEDs

2835 SMD Type

HL-9275

Package Configuration

Descriptions:
Emitting Color: Yellow
Device Outline: 2.8x3.5x0.8mm
Lens Type: Water Clear

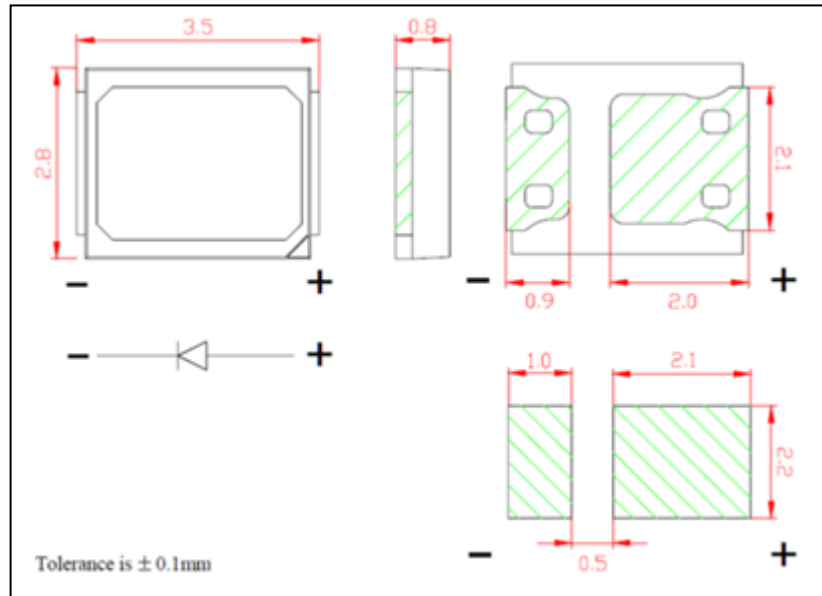

Absolute Maximum Ratings (Ta=25°C)

Parameter	Max.	Unit.
Peak Forward Current (1/10 Duty Cycle, 0.1ms Pulse Width)	1000	mA
Continuous Forward Current	150	mA
Reverse Voltage	5	V
Operating Temperature Range	-40 °C to +85°C	
Storage Temperature Range	-40 °C to +100°C	
Lead Soldering Temperature [4mm (.157") From Body]	250°C for 5 Seconds	

Electrical and optical characteristics

Parameter	Symbol	Min.	Typ.	Max.	Unit.	Test Condition
Luminous Intensity	I_v	4200	-	5900	mcd	$I_f=150\text{ mA}$
Viewing Angle	$2\theta_{1/2}$	-	120	-	deg.	
Dominant Wavelength	Δd	-	590	-	nm	